



Drainage and Grease Management for the Commercial Kitchen

ACO Industrial and Commercial Drainage

Hygiene**First**



The ACO system chain provides the drainage solutions to meet the future needs of the Food & Beverage Industry.

Today, when food can be produced in any corner of the world and land on your table, it is important, maybe more than ever before, that food is processed in an environment which is 100% safe. No detail should be missed, therefore it is absolutely essential that every facility where food is processed in anyway is equipped by more complex and sophisticated drainage concepts. ACO achieves this with intelligent system solutions which address optimal food safety, people and water protection. Every ACO product within the ACO system chain therefore safely controls the water as it passes along the chain to ensure that it can be hygienically, economically and ecologically handled in a viable way.



collect:

The surface water or the liquids being treated are collected as quickly and as completely as possible by the drainage system. This part of the ACO system chain guarantees protection, safety and comfort for the people, buildings and traffic routes in the immediate vicinity.



clean:

The collected liquids are treated using integrated physical, chemical or biological processes that ensure they can be discharged into public sewers – the minimum requirement. This part of the ACO system chain creates the conditions for recycling and sustainable use.



hold:

Containers, barriers and valves ensure that liquids stay within the drainage system where they can be properly controlled. This part of the ACO system chain enhances the protection and safety of food, your building and the environment.



reuse:

Pumps, lifting plant and pipe systems transfer the collected, treated and controlled water into the downstream systems and processes. This part of the ACO system chain brings the collected, treated and controlled water to the interfaces for further treatment, re-use or release.



Content

ACO System Chain	02
<hr/>	
About ACO	04
<hr/>	
HygieneFirst	06
<hr/>	
Drainage and Grease Management for the Commercial Kitchen	08
<hr/>	
Drainage Management	10
<hr/>	
Grease Management	14
<hr/>	
ACO Product Overview	20
<hr/>	
ACO Service Chain	22
<hr/>	
References	23
<hr/>	

ACO.

we care for water

The worldwide ACO Group. A strong family you can build on

The ACO Group is a world market leader in drainage technology. Climate change sets us a challenge to react effectively with innovative solutions to new environmental conditions. With its integrated approach, ACO stands for professional drainage, efficient cleaning, and the controlled discharge or reuse of water. Products include drainage channels and drains, oil and grease separators, backflow stop systems, pumps and pressure-water-tight cellar windows and light shafts.

The family-owned company headquartered in Rendsburg/Büdelndorf, Germany, was founded in 1946 on the site of the Carlshütte foundry – Schleswig-Holstein's first industrial company. It still has very strong roots in the region. The innovation strength of the ACO Group is built on intense research and development, and its technical expertise in processing polymer concrete, plastic, cast iron, stainless steel and reinforced concrete.

www.aco.com



Headquarters of the ACO Group
in Rendsburg/Büdelndorf

5,200

employees in more than 47 countries (Europe, North and South America, Asia, Australia, Africa)

1 Billion

Euro Sales in 2021

37

production sites in 18 countries



ACO Academy
for practical training

Holder
Iver and Hans-Julius Ahlmann



Hygiene**First**

As one of the world's leading commercial drainage specialists, ACO Group understands the critical role that drainage plays in a successful commercial food preparation business. We appreciate that food safety, hygiene and cost control are all vital factors yet we also understand that for many, drainage is out of sight and therefore out of mind.

As a result, many drainage systems are not designed well. At best this leads to costly on going cleaning and maintenance, and at worst it can result in food contamination, closure of a facility and the loss – or even closure – of business. As the company that's driving the future of drainage, we are determined to change this by raising the profile of hygienic drainage and improving standards across every part of the process.

Our HygieneFirst philosophy represents our commitment to delivering products that provide ultimate hygienic performance. We design intelligent drainage solutions that minimize operational costs without compromising food safety.





Drainage and Grease Management for the Commercial Kitchen

Commercial kitchens are extremely busy environments with potentially wet and greasy floors due to the abundance of liquids used in both the cooking and cleaning processes, and of course, liquids are often very hot! Waste water can also contain fat which is a major cause of pipe blockages and cannot be released to the waste water system. In combination, these factors may affect Food Safety, Operational cost and Health & Safety.

Food safety

Food safety can be severely affected due to poor drainage and grease separation systems. ACO solutions are designed to effectively and safely drain away and handle process water. We design our products specifically to reduce the risk of food contamination.

Cost control

Management of costs is a major factor in business today. Commercial kitchen equipment including drainage and grease separation systems should fulfil its function with low operational cost in mind throughout its entire lifespan. ACO drainage and grease separation systems are designed so they can be easily maintained, reducing associated cleaning costs and maximising hygienic performance.

Health & safety

Minimizing the risk of injury in the workplace is of prime importance to any commercial kitchen facility. It's essential that your facility has a drainage system which improves health and safety conditions during cleaning, emptying and operation, while ensuring hygiene is always front of mind.



Drainage Management

Hygienic standards in the commercial kitchen industry are rising. ACO is meeting these changing demands by incorporating hygienic design principles, industry best practice and the guidelines of bodies including the European Hygienic Engineering and Design Group (EHEDG) into the design of its drainage solutions.

Operational costs are a major factor in business today. Every product and system needs to fulfil its function efficiently throughout its entire lifespan. ACO provides the expertise and quality necessary to provide the perfect balance between high levels of food safety and operational cost.

The kitchen is a potentially hazardous environment because of the ever-present element of heat, liquids and grease. ACO drainage systems are specifically designed to reduce the build-up of liquids by disposing of water and grease effectively and immediately.

Food safety features of ACO drainage

ACO hygienic drainage fulfils hygienic requirements to prevent harmful bacteria contamination. We apply relevant hygiene design principles reserved for food contact surfaces recommended by EHEDG.

Our product design ensures minimal build-up of food particles and debris as well as a safe connection with the surrounding floor to minimise any opportunity for bacteria to grow throughout the drainage system.

Sleek slope function and hygienically designed products ensure our system is fully drainable eliminating the stagnant odour of waste water.

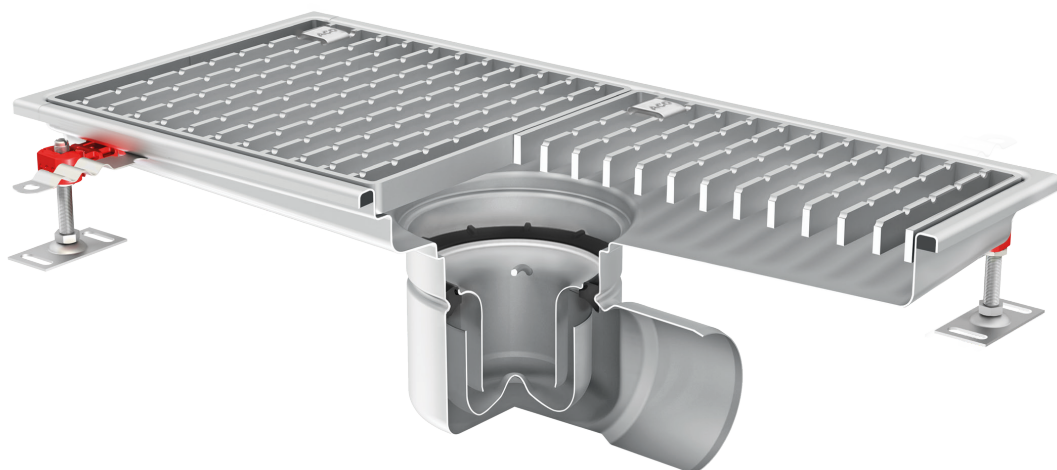
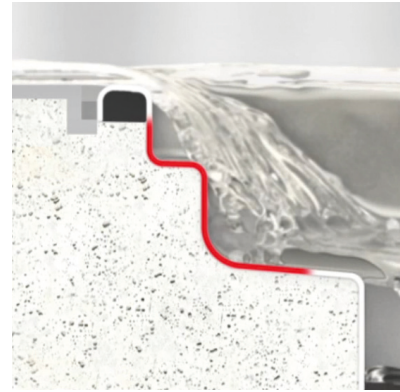
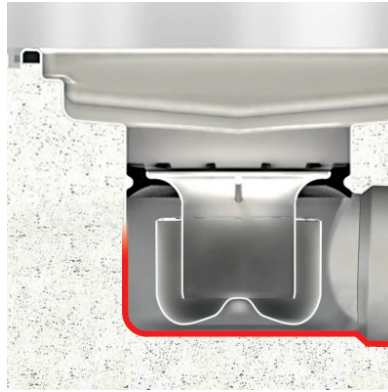

Cost control features of ACO drainage

ACO drainage system can be easily maintained, reducing associated cleaning costs thanks to their functional design and cleaning recommendations which have been developed in partnership with premium cleaning agent suppliers.

ACO's advanced manufacturing technologies ensure durability and our special surface treatment guarantees corrosion resistance. Our systems perform effectively at all times and keep disruption to a minimum.

We provide expertise in drainage system planning, correct installation and creating a safe connection with the surrounding floor to avoid unnecessary cost.

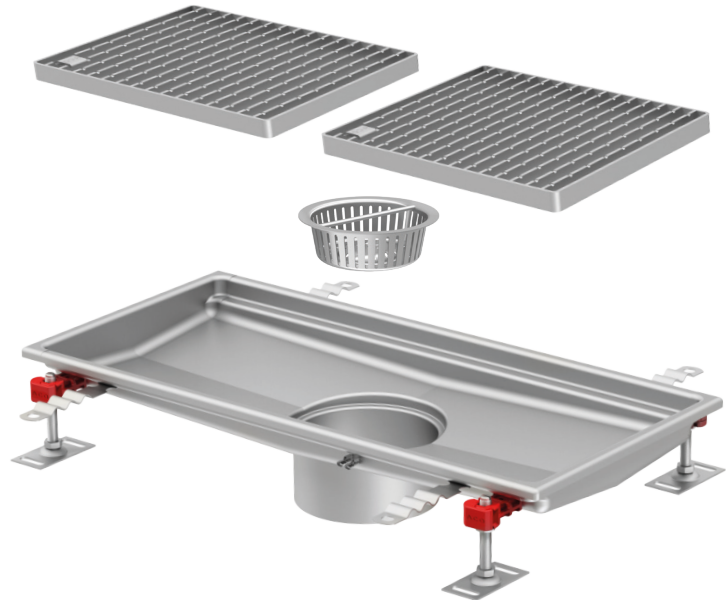

Health & Safety features of ACO drainage

For additional safety in high risk areas that require heavy water usage is available slip resistant ladder and cast grating.

Each component of the drainage system is easy to remove and clean, and there are no sharp edges for optimum employee safety.

ACO drainage products have a fire resistant solution certified according to EN 136.

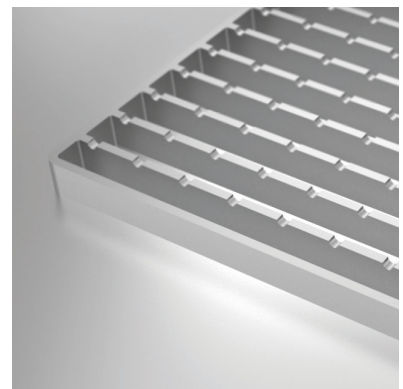
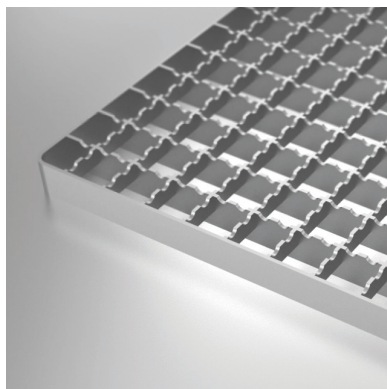



ACO

Grease Management

Commercial kitchens generating waste water must have pre-treatment plants to ensure that solids and liquids that release harmful or unpleasant vapours or interfere with operations are not discharged into the public sewerage network.

In addition to odour reduction, ACO systems also reduce the amount of work required to handle grease disposal and cleaning. For example, if a grease separator features automated cleaning, it is no longer necessary to use external cleaning equipment. The use of the filling device also allows refilling to take place directly at the separator.

Health & Safety is of prime importance in a commercial kitchen operation with particularly attention being paid to process reliability and fire prevention.

Food safety features of ACO grease separators

System ACO grease separators eliminate unpleasant smells during cleaning and disposal.

Effective hydro mechanical high pressure 360° internal cleaning (175 bar) removes all residue in the separator.

Grease separators are available in stainless steel for optimal hygiene.

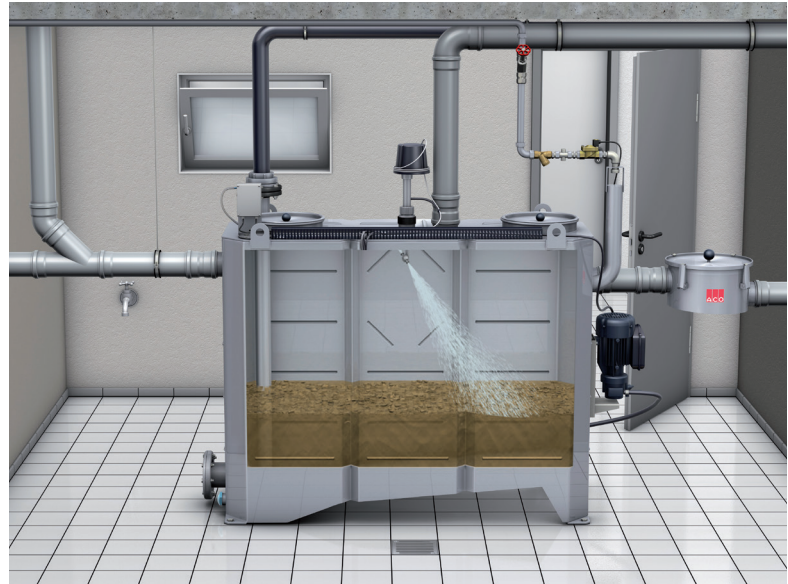

Cost control features of ACO grease separators

ACO grease separators automatically measure the grease layer, so the operator knows when they need emptying.

Operational flexibility is ensured by our GSM Mobile module. Information about inspections and maintenance needs are sent to mobile phones.

Operational cost are optimised due to automatic cleaning and grease disposal.

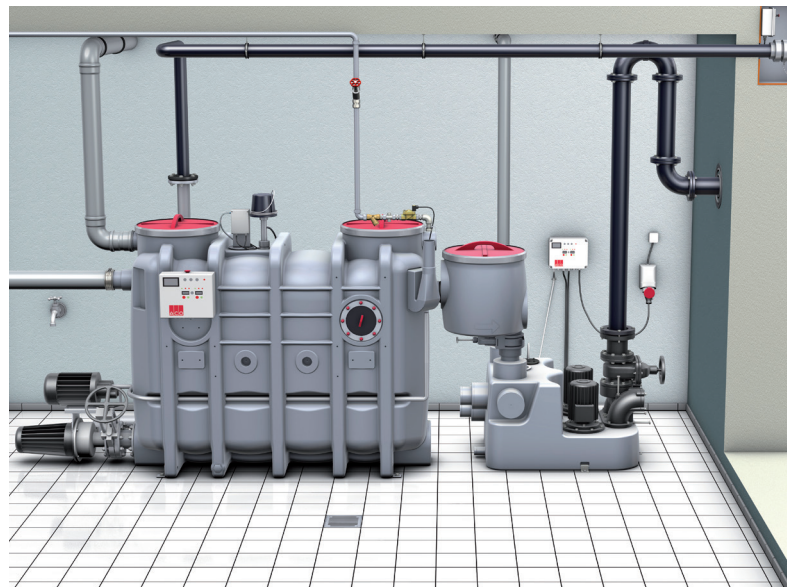

Health & Safety features of ACO grease separators

Benefiting from automatic cleaning, ACO's grease separator eliminates any health and safety risk during disposal and cleaning.

Sizing, layout and the right solution specification support ensure safe installation and maintenance.

ACO grease separators offer a stainless steel incombustible solution.

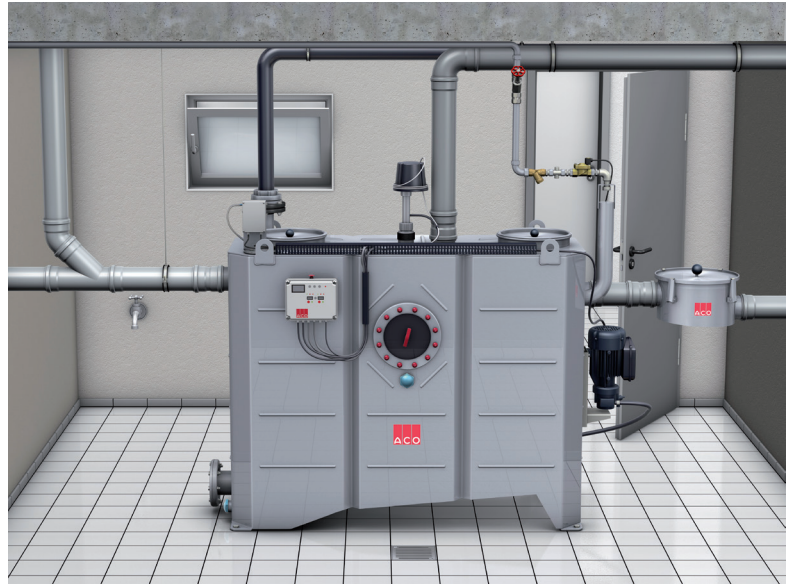

Commercial Kitchen

There are three principal areas in every commercial kitchen: the storage and preparation area, the production area, and the washing and disposal area. Each area handles different processes in the commercial kitchen environment and has different demands for waste water management. Nevertheless there are some aspects which are common for all three.



A well-designed drainage system should have:

- A debris filter at outlet
- Easily removable non-slip gratings
- Easily removable foul air trap
- Hygienic design to avoid bacteria traps
- Proper volume capacity size
- A grease separator for removal of fats and grease

Storage area

Preparation area

▶ Drainage Management



ACO hygienic gully



ACO modular box channel

▶ Grease Management

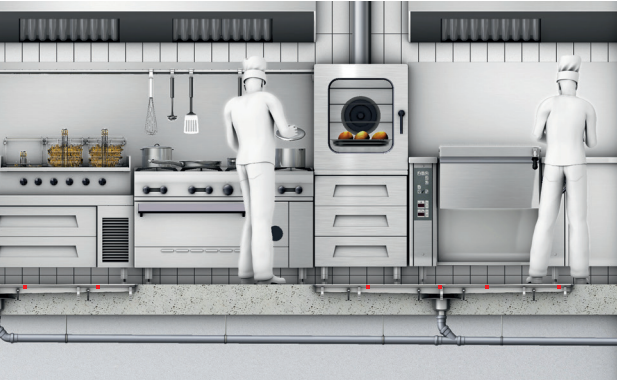

Production area

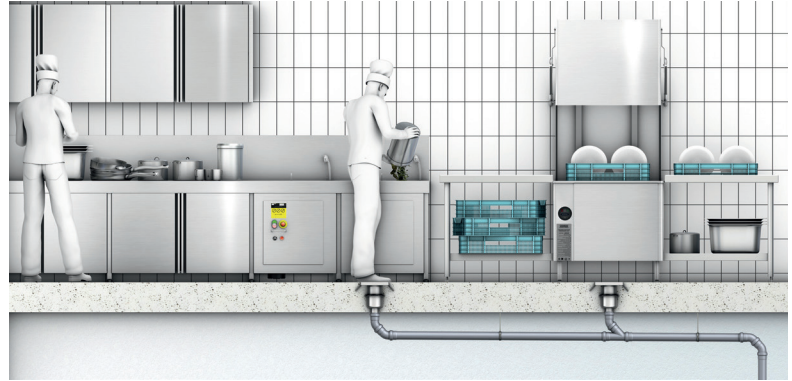

Washing area

Disposal area



ACO hygienic box channel

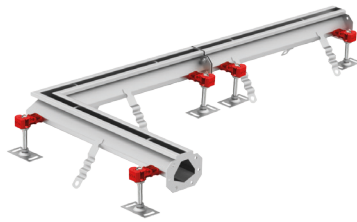

ACO modular slot channel



ACO pipe



ACO Lipumax P-DA



ACO Lipurat-RAE

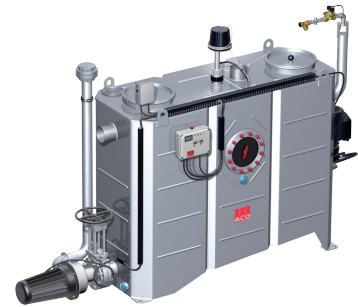

ACO Lipurat-OAE

Product Overview

ACO hygienic gully

The ACO hygienic gully range incorporates hygienic design principles to ensure the optimum hygienic performance. ACO hygienic gullies are available in various body sizes to cater for different flow rates and construction requirements including shallow construction depths and applications where preventative fire measures are required. ACO hygienic gullies are certified according to EN 1253.



ACO hygienic box channel

The ACO hygienic box channel range incorporates hygienic principles to ensure the optimum hygienic performance. The hygienic box channel range is ideal for applications where high standards of hygiene are required as they are capable of handling large volumes of fluid. ACO hygienic box channels are certified according to EN 1253.

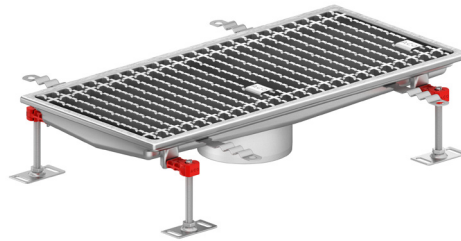

ACO modular slot and ACO modular box channels

Our modular range with standardised widths provides a most versatile system with off-the-shelf availability. Accessories such as corner units and a choice of grating make this system perfect for a wide range of applications. Certified to EN 1433, CE marked.



ACO pipes

The ACO stainless steel push-fit pipe system is designed for grey or black water. ACO pipe offers a product life in excess of 40 years thanks to use of stainless steel. Easy installation and on-site handling is ensured by push-fit assembly. ACO pipe is more hygienic, robust and durable than plastic pipe systems for gravity and vacuum drainage.



ACO grease separators

A comprehensive range caters for all size requirements within the EN 1825 specification, with performance at or beyond the standard's requirement. Our separators can be specified with varying degrees of sophistication: grease removal and cleaning maintenance can be automated, mini-mixing disruption in busy catering environments. Separators are tested and certified according to EN 1825 and are therefore CE marked.



ACO Service Chain

As the leading manufacturer of drainage solutions, we pride ourselves in being experts in everything relating to drainage. We are always happy to share our comprehensive expertise with our partners on the selling side, as well as architects, planners and the trades. This not only helps us simplify your working day but also enables us to safeguard the quality and the market leadership of ACO solutions.

train: Information and further education

We share the global expertise of the ACO Group with dealers, planners, architects and installers who prioritise quality. We invite you to profit from our expertise and attend a number of CPD training sessions organized by us.

support: Construction advice and assistance

We provide you with project-related advice and support to ensure that no unpleasant surprises occur between the planning and realisation of a drainage solution.

design: Planning and optimisation

There are many different options when it comes to the specification and design of drainage solutions but which concept produces the most economical, hygienic and safest technical solution? We'll help you find the right answer.

care: Inspection and servicing

ACO products are designed and built for long service. Our customer care services also ensure that ACO continues to satisfy your high quality requirements year after year.



ACO Service Chain

References



Nestlé Terni Italy



Budweiser Xuejin Beer Co., Ltd. (Putian) China



Coca-Cola India



Steinex Czech Republic

From top left to bottom right: **Nestlé Terni Italy** Froneri is a company focused on ice-cream, frozen food and chilled dairy products. This company brings together years of manufacturing expertise and business from Nestlé and R&R, branding delicious dessert treats. Froneri is currently the second largest ice cream manufacturer in the region of Europe and also worldwide the third largest. **Budweiser Xuejin Beer Co., Ltd. (Putian) China** was founded in 2002 with a registered capital of approximately 91.2 million yuan and more than 10,000 employees. It is located in the western part of the Budweiser InBev Food Industrial Park in the Hanjiang District of Putian City in the Fujian Province. **Coca-Cola India** Sri Sarvaraya Sugars limited manufacturer Sugar, Industrial Alcohol, Carbonated and Non-Carbonated Soft Drinks and Bottled Water at its Plants in East Godavari and Khammam Districts of Andhra Pradesh and is an Authorised Bottler of The Coca-Cola Company, U.S.A. **Steinex Czech Republic** meat processing company is a large family business focused on innovations, dynamic development and passion for the future business. Steinhauser family has been working in the meat industry for over five generations. Steinex brand story began in 1994 and since then they not only produce and process the meat, they have also a network of meat stores. Passing the experience from father to son helped them become one of leading local industry's producers. Factory serves the whole CEE region with the sales of 16 million EUR.

Every ACO product supports
the ACO system chain



- Floor drainage
- Bathroom drainage
- Parking deck drainage
- Roof drainage
- Balcony and terrace drainage
- Pipe systems
- Wall protection
- Grease separators
- Starch separators
- Light oil separators
- Process technology
- Backflow systems
- Lifting stations
- Pumping stations

ACO Industries k.s.

Havlíčková 260
582 22 Příbyslav
Czech Republic

www.buildingdrainage.aco

ACO. we care for water

