



Individual in function and design

ACO DRAIN® Multiline

- drainage channels made of polymer concrete
- new as well as tried and tested Drainlock gratings



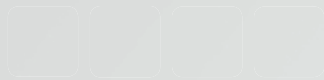

ACO. The future of drainage.



The ACO system chain creates the drainage solutions for the environmental conditions of tomorrow.

Increasingly extreme weather conditions require more and more complex drainage concepts. Here, ACO creates intelligent system solutions that function in both directions: they protect man from water – and vice versa. Every ACO product within the ACO system chain secures the path of the water, with the objective of being able to recycle it in an ecologically and economically meaningful way.

Within the ACO group, ACO Civil Engineering supports the global system chain and with its drainage systems, which are world leaders, creates future-oriented and safe system solutions for transport infrastructures in the fields of civil engineering and landscaping.



collect:
collecting and picking up

- drainage channels
- street and yard drains
- gully tops
- manhole covers



clean:
pre-cleaning and preparing

- separators



hold:
holding back and retaining

- water pollution prevention
- block storage



release:
pumping, diverting and re-using

- block infiltration
- pumping stations
- tree protection



ACO system chain in action

Contents

You have the choice! 04

Drainlock gratings 07

Ladder gratings	08
Elongated and diagonal bar gratings	10
Longitudinal bar grating	11
Longitudinal profile gratings	11
Mesh gratings	12
Perforated gratings	13
Cover plate	13
Slotted frame	14

Illuminated Drainlock gratings:

Lightpoints	16
Eyeleds	18
Sideline	21

Individual Drainlock gratings:

Freestyle cast iron gratings	22
------------------------------	----

Channel bodies

ACO DRAIN® Multiline 25

Polymer concrete	26
System advantages	28
System overview	29
Drainlock safety lock	30
Underground piping connections	31

Ordering information

about the new Drainlock gratings 32

The ACO Multiline grating configurator	34
The ACO Service Chain	35

Drainlock gratings

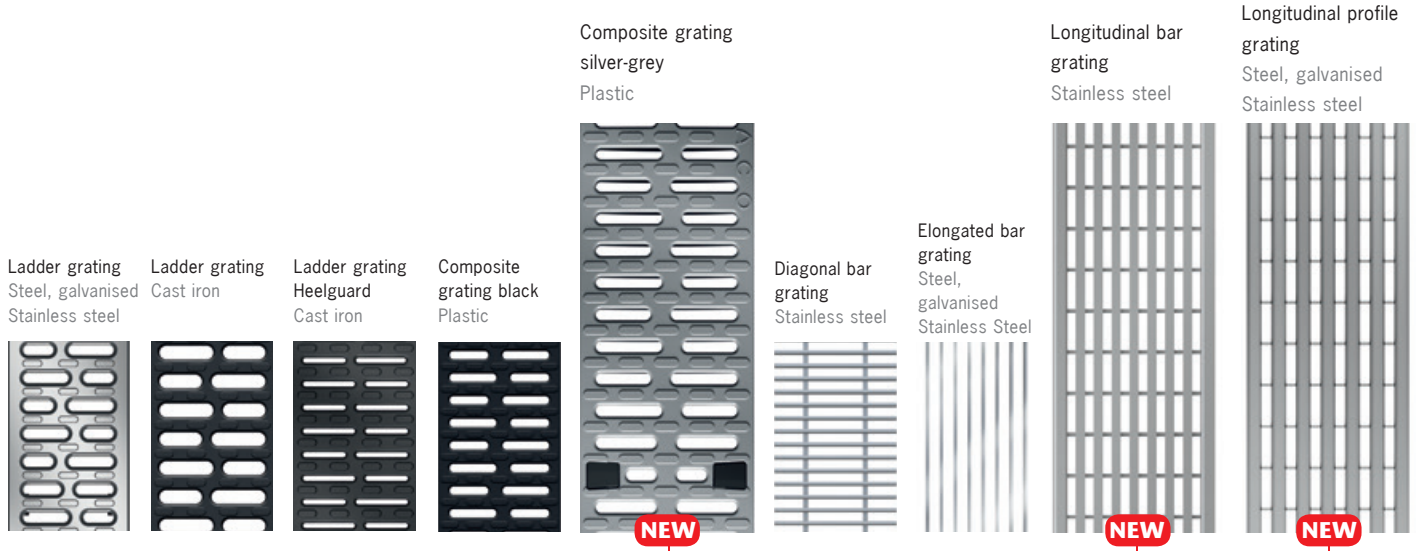

NEW

NEW

NEW



You have the choice!

ACO DRAIN® Multiline Channel bodies

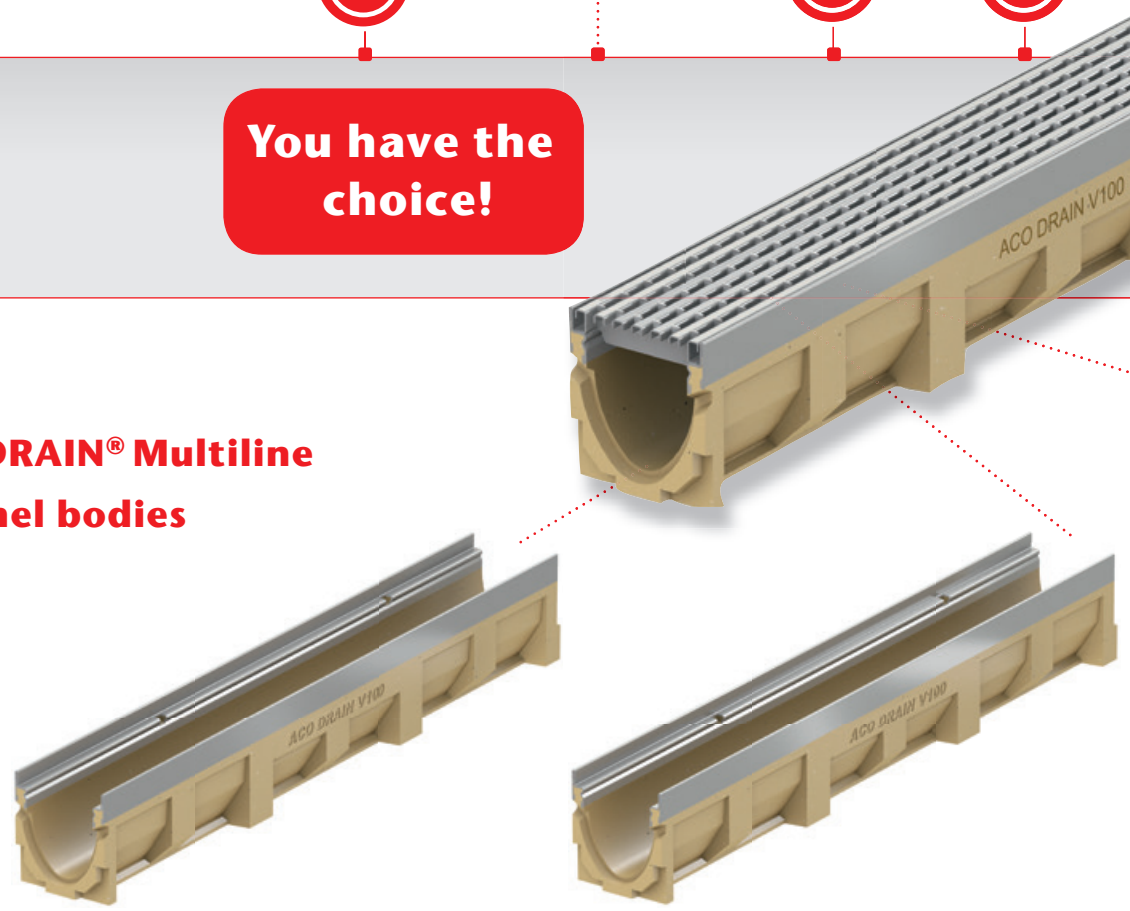

Frame: steel, galvanised

Frame: stainless steel

Q+ Mesh grating
Steel, galvanised
Stainless steel

Freestyle
Cast iron grating

Elongated bar
grating with
mesh appearance
Cast iron

Mesh grating
Steel,
galvanised
Stainless Steel

Perforated
grating
Steel,
galvanised
Stainless steel

Cover plate
closed
Cast iron

Slotted frame
Steel, galvanised
Stainless steel

Lightpoint
Cast iron

Eyeleeds
Plastic

Sideline
Steel,
galvanised

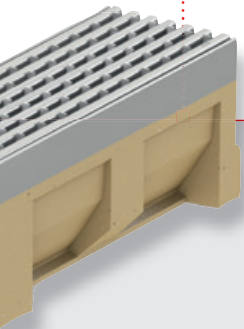
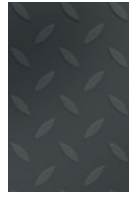
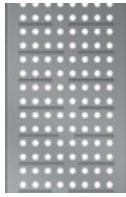
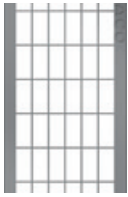
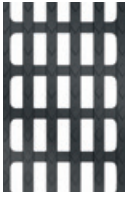

Frame: Cast iron

- heelguard: Slot width max. 10 mm
- non-slip: according to DIN 51130 min. R 11
- hydraulics: optimised intake area
- individual: unmistakable grating designs



Drainlock gratings

For the ACO DRAIN® Multiline

A wide range of covers in many shapes, colours and materials – made of cast iron or stainless steel, hot-dip galvanised steel or plastic – provide creative scope for individual planning and design. The Drainlock gratings of the ACO DRAIN® Multiline system meet architectural requirements in terms of aesthetics, functionality and load. The gratings can be combined irrespective of the channel body and are available in the load classes from A 15 to E 600.

The material of the Drainlock gratings should match the frame versions of cast iron, galvanised steel and stainless steel.

Using the same material for the frame and the cover provides a uniform visual impression and avoids contact corrosion.



Drainlock gratings

Ladder gratings

Ladder gratings by ACO with slot widths of up to 10 mm protect your heels. You have the choice between gratings in galvanised steel, stainless steel and cast iron. The "Heelguard" ladder grating made of cast iron, with a slot width of only 5 mm, even offers high heels a stylish and safe footing at all times. This makes it ideal for public areas in cities.

- ladder grating steel, galvanised/stainless steel, nominal width 100 mm, load classes A 15 and C 250
- „Heelguard“ ladder grating, cast iron EN-GJS, nominal width 100 mm, load class C 250
- ladder grating, cast iron EN-GJS, nominal widths 100, 150, 200, 300, 400 and 500 mm, load classes B 125, C 250 and D 400
- according to DIN EN 1433/DIN 19580
- with Drainlock screwless stop



Ladder grating
Steel, galvanised



Ladder grating
Stainless steel



„Heelguard“ ladder grating
Cast iron

Slot width only 5 mm



Ladder grating
Cast iron





Composite grating black
Plastic



Composite grating silver grey
Plastic

Ladder gratings made of plastic

Composite gratings represent the absolutely rust-free alternative to covers made of metal. This protects adjacent surface coatings from discoloration caused by rust transmission. Further advantages of the exceedingly robust silver grey or black plastic gratings are their colour fastness as well as their high resistance to wear and chemical agents. And they also feature "heel-guard".

- plastic grating,
nominal width 100 mm
- load classes B 125 and
C 250 (black only)
- according to DIN EN 1433/DIN 19580
- with Drainlock screwless stop





Elongated and diagonal bar grating

The simple elongated bar gratings, available in galvanised steel or stainless steel, and the diagonal bar grating made of stainless steel fit unobtrusively into all floor coverings. An elongated cast iron bar grating is available with a rustic mesh appearance.

- cast iron EN-GJS, nominal widths 100, 150, 200, 300 and 400 mm, load classes C 250, D 400 and E 600
- optionally steel, galvanised/stainless steel, nominal width 100 mm, load class A 15
- diagonal bar grating stainless steel, nominal width 100 mm, load class B 125
- according to DIN EN 1433/DIN 19580
- with Drainlock screwless stop



Elongated bar grating
Cast iron

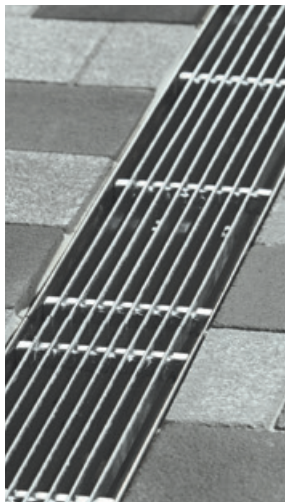

Elongated bar grating
Galvanised steel and stainless steel



Diagonal bar grating
Galvanised steel



Longitudinal bar grating



With the new longitudinal bar grating made of high-quality stainless steel, ACO is emphasising design. This grating is particularly suitable for installation in front of glass façades. Thanks to its free intake area, it quickly drains off any surface water. A slot width of only 6 mm makes the grating especially anti-slip – an elegant solution for line drainage on façades and also at the interface between the façade and the open area.

- grating made of stainless steel, nominal width 100 mm
- load class B 125
- according to DIN EN 1433/DIN 19580
- with Drainlock screwless stop
- pickle passivated and grinded surface

Longitudinal profile gratings



The longitudinal profile grating meets the highest safety requirements and thus sets new standards in line drainage: it has been awarded the "heelguard" seal and with slot widths of 8 mm is anti-slip. In addition, this grating, which is available in galvanised steel and stainless steel, has a slip-proof structure. The free intake area guarantees fast drainage, and the continuous U-shaped profile also ensures clear visual lines. As an additional design option, this grating can be electro-polished on demand.

- optionally steel, galvanised / stainless steel nominal width 100 mm
- load class B 125
- according to DIN EN 1433/DIN 19580
- with Drainlock screwless stop
- pickle passivated surface in stainless steel



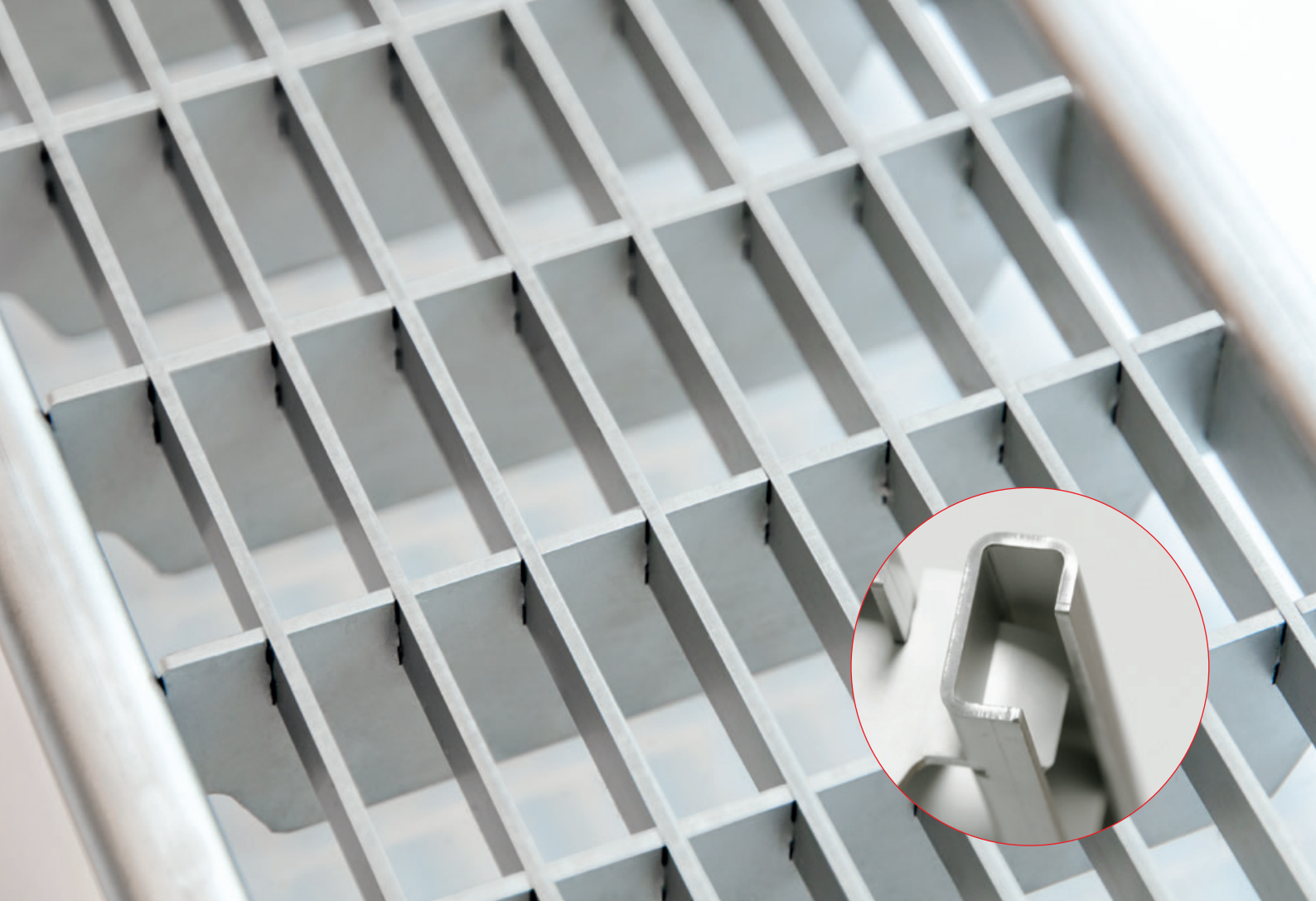

Q+ mesh gratings



For the Q+ mesh grating, we have optimised the tried and tested ACO mesh grating: the specially designed support frame guarantees a free intake area and thus particularly fast surface drainage and dry feet – aquaplaning is a thing of the past! On account of its generous absorption capacity, the grating, which is available in galvanised steel and in stainless steel, is particularly suitable for installation in front of ramps. The continuous longitudinal rods are aesthetically pleasing. As an additional design option, this grating can be electro-polished on demand.

- optionally in steel, galvanised/stainless steel,
- nominal widths 100 mm, classic mesh grating also 150, 200 and 300 mm
- load class B 125
- classic mesh grating, also C 250 and D 400
- according to DIN EN 1433/DIN 19580
- with Drainlock screwless stop
- pickle passivated surface in stainless steel



Q+ mesh grating
Steel, galvanised
Stainless steel



Mesh grating
Steel, galvanised
Stainless steel

Perforated gratings

The unobtrusive grating with the uniform hole pattern is visually restrained. Especially with distinctive, large-area floor coverings, effective contrasts can be achieved with the versions in galvanised steel or stainless steel.

- optionally in steel, galvanised / stainless steel,
- nominal width 100 mm
- load classes A 15 and C 250
- according to DIN EN 1433/DIN 19580
- with Drainlock screwless stop

Cover plate

The closed cover plate made of cast iron is indispensable for covering cable ducts.

- cast iron EN-GJS,
- nominal widths 100, 150, 200 and 300 mm
- load class E 600
- according to DIN EN 1433/DIN 19580
- with Drainlock screwless stop



Perforated grating
Steel, galvanised
Stainless steel



Cover plate
Cast iron



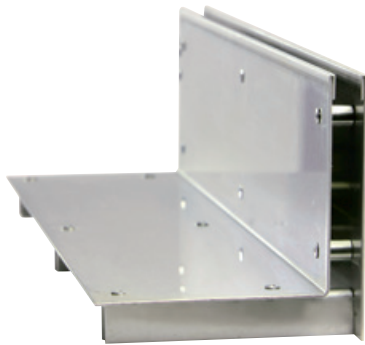

Slotted frame

Design with clean lines. Discreet and unobtrusive, the slotted frame opens up new opportunities in the planning of your open areas. A narrow slot replaces the grating and forms a clear, inconspicuous joint in the surface. This line can follow the course of the architecture as a design element.

This system is also ideal as a transition between two surfaces. The slot support is compatible with common paving stones or stone slabs, and joins up the surfaces almost seamlessly. This type of drainage is ideally suited to surfaces that have to meet high architectural standards.

- optionally in steel, galvanised / stainless steel,
- nominal widths 100 and 150 mm
- load classes C 250 and D 400
- according to DIN EN 1433/DIN 19580





Lightpoints

With ACO Lightpoints, surfaces that are particularly exposed to higher loads can be attractively upgraded so that they look their best. Together with the ACO DRAIN® Multiline drainage channel as well as cast iron gratings of load class D 400, the system offers high-quality line drainage together with interesting design options.

The LED lights in white or blue, encased in stainless steel, give open areas or driveways a certain emphasis. Public areas as well as busy entrance areas are upgraded in terms of design and function.

- cast iron EN-GJS,
- nominal widths 100 and 200 mm
- load class D 400
- Basic set:
 - 2 LED Lightpoints in white or blue, as well as wiring and transformer
 - according to DIN EN 1433/DIN 19580
 - with Drainlock screwless stop



Lightpoint



Practical example

5 Lightpoints on a 2,5 m channel

Components required:

- 1 x basic set, 3 x extensions
- 2 x channels 100 cm
- 1 x channel 50 cm
- 5 x Lightpoint cast iron gratings
- 2 x universal closing end caps

Protected installation location
Line 1
Supply line 3,5 m

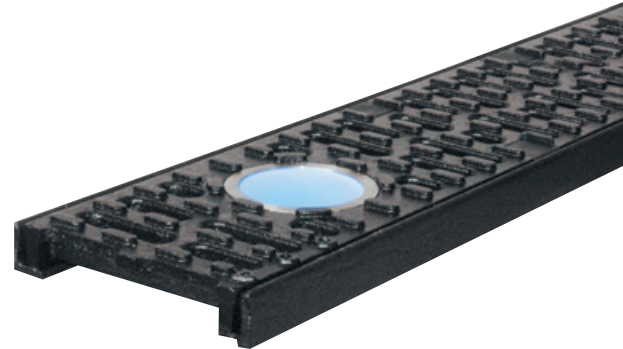
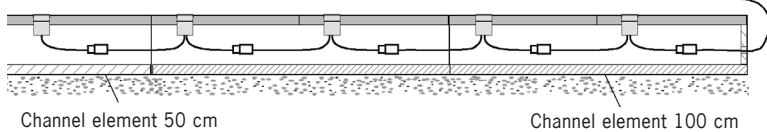
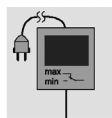

Eyeleds

Light and expressive – to match the ACO DRAIN® Multiline, there is the plastic grating, class B 125, in black with lighting. Although the diameter of the lamps is only approx. 20 mm, the LED technology provides an intensive lighting effect. Garage entrances, squares, paths, pedestrian precincts, access roads, boulevards or train platforms can be effectively presented with ACO Eyeleds. Besides their decorative function, ACO Eyeleds as orientation or marking lights contribute to safety in busy public areas.

ACO Eyeleds are characterised by extremely high watertightness and a service life of approx. 100,000 hours – with constant, intense light in white or blue. The lighting systems are installed by simply linking up the cable connections. Up to 40 Eyeleds can be connected to one transformer.

- plastic, nominal width 100 mm
- load classes B 125
- LED light colour: white or blue
- according DIN EN 1433/DIN 19580
- with Drainlock screwless stop



Eyeleds
Space between the
LED lamps 50 cm
Plastic



Eyeleds
Space between the
LED lamps 100 cm
Plastic

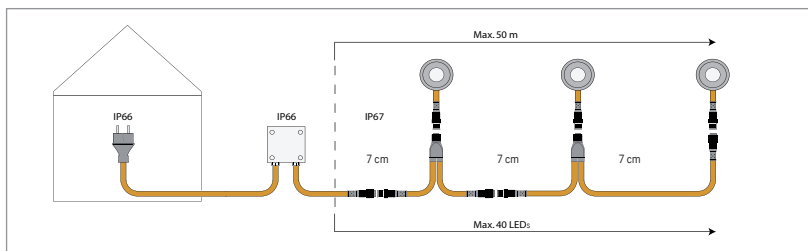

Practical example

5 ACO Lightpoints on a 2.5 m channel

Components required:

2 x channels 100 cm

1 x channel 50 cm

5 x plastic gratings with Eyeled

1 x transformer

4 x splitters 30/30

2 x universal closing end caps





Mounting the LED elements in the slotted frame



Sideline
Stainless steel



Sideline

Drainage channels disguised as narrow slots guarantee clean lines on squares and pathways, in gardens and parks. Slotted frame drainage now has a new design dimension: it holds new lighting effects. The ACO Sideline shows a well thought-out symbiosis of drainage and LED technology.

Besides the effective design, an important advantage is the improved feeling of safety achieved through the combination of slotted frame drainage and LED technology. The linear light tracks also underscore the character of modern architecture.

A user-friendly control unit allows solutions ranging from small applications to complex integration in all building automation systems. The energy-efficient IP 67 LED lamps are highly resistant and maintenance-free.

Versions in the lengths of 1,000 and 500 mm are available. In the RGB version, a 6 m light line can be connected to one power supply.

Maintenance for the drainage channel is effected using service components. Inspection elements allow easy cleaning and fast access to the cables. With the help of the 100 mm high slotted frame, paving stones can be accurately aligned with the slots.

- made of stainless steel,
- nominal width 100 mm
- LED light colour: monochrome or RGB
- (All colours, mixed colours, colour gradations, colour changes; dynamic lighting scenes are also possible.)
- load class C 250
- according to DIN EN 1433/DIN 19580



Freestyle cast iron gratings

Creative yet safe. Would you like to have individual solutions in your landscape architecture? For line drainage, this wish can quite easily come true: with Freestyle cast iron gratings, ACO offers its customers a unique opportunity to design the visible surface of the grating themselves. You design it – let us worry about the details!

Variable production tools allow imaginative design drafts which offer the planner many different opportunities to design the surface to be drained. In this way, unmistakable grating designs can very easily be used for special locations. We supply you with your grating, designed according to your wishes, for example with anti-slip surface structure and slot widths of only 8 mm. In this way, safety is not neglected either.

- ductile iron EN-GJS
- nominal widths 100, 150, 200 and 300 mm, length 500 mm
- coated or uncoated
- load class D 400
- according to DIN EN 1433/DIN 19580
- with Drainlock screwless stop



Drainlock gratings



ACO Freestyle cast iron gratings designed according to customer's wishes: ACO Freestyle Flag, ACO Freestyle Leaf, ACO Freestyle Sturgeon



ACO Freestyle with lighting using Eyeleds





ACO DRAIN-V300

ACO DRAIN-V300

ACO DRAIN-V300

ACO DRAIN® Multiline

Line Drainage

ACO DRAIN® Multiline is based on a system idea that offers advantages for everyone: for planners, dealers, building companies and builder-owners. Five load classes, six nominal widths, three frame versions – an innovative concept. Planners save time with the invitation to tender, because the Multiline system idea allows a high level of standardisation of the interfaces. Dealers benefit from the highly streamlined range. And builder-owners can enjoy sophisticated solutions for design and construction, for Multiline combines variety of design, a high degree of functionality and extreme durability.



Tried and tested material:

Channels bodies made of ACO polymer concrete

ACO DRAIN® drainage channels – like ACO DRAIN® Multiline – are made of polymer concrete and have significantly higher mechanical strength properties and lower weight than comparable concrete products of comparable density. The low weight of the finished parts simplifies handling as well as installation, and cuts costs. Polymer concrete is impermeable to water.

Water dries off quickly. Damage as a result of frost can be ruled out.

The smooth surface of ACO polymer concrete allows water and dirt particles to flow off quickly, and is easy to clean. ACO polymer concrete is also resistant to aggressive media, even without additional coatings, and is thus versatile and durable even under extreme conditions.



The lower, narrower area of the V-shaped cross section allows significantly higher flow rates, even at low water levels, thus guaranteeing an optimum self-cleaning effect



The complete tightness of the channel body up to the top edge of the frame and the smooth surface increase the drainage volume under peak loads, for example during thunderstorms



- tightness: no water absorption
- resistance to frost, de-icing salt, chemicals, and in a special mixture is flame-resistant
- weight: low weight of finished part
- hydraulics: high flow rate thanks to V-shaped cross section
- quality: Product and independent quality testing by Kiwa, type testing by Güteschutz Nord e.V.



System advantages

The ACO Multiline system offers numerous advantages for all those involved in construction:

Relief of strain

during planning and processing due to fewer system components. Every channel body in every nominal width can be used for load classes A 15 to E 600.

Comfort

during planning due to the high level of standardisation of the interfaces as well as comprehensive support in the planning and invitation to tender phase.

Added value

for the builder-owner thanks to intelligent design and construction solutions. The channel body as well as the details and materials of the frames and gratings guarantee aesthetic variety, a high level of functionality and extreme durability.

Simplification

for trade in stockkeeping and logistics. The reduced number of system components allows leaner stockkeeping, which in turn ties up less capital.

Safety

thanks to a channel section which simply drains better. The entire product family complies with or exceeds all current standards and regulations, including of course those in DIN EN 1433 / DIN 19580.



System overview

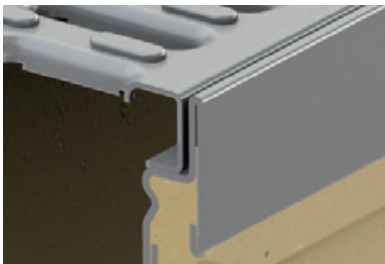

Galvanised steel

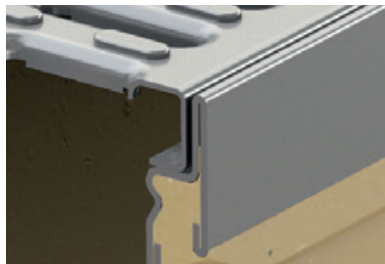

Stainless steel

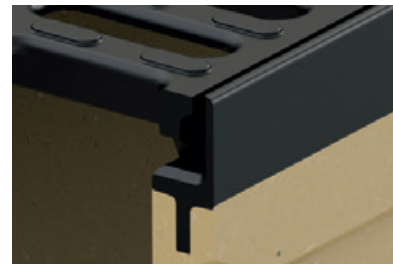

Cast iron

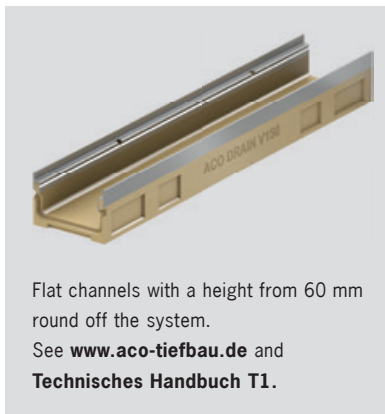

Large choice of materials for all nominal widths and load classes. The three frame versions in galvanised steel, stainless steel or cast iron offer the planner a free choice of cover gratings with a consistent material appearance, without the risk of contact corrosion between the grating and the frame.

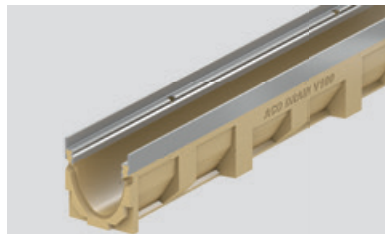

Multiline V 100

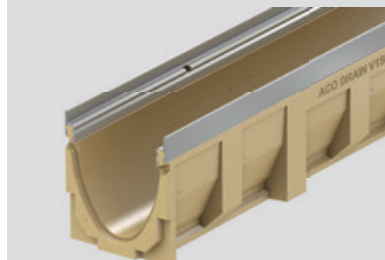

Multiline V 150

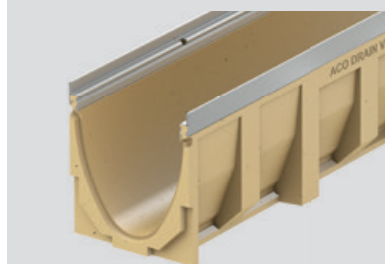

Multiline V 200

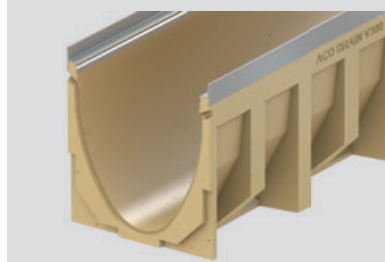

Multiline V 300

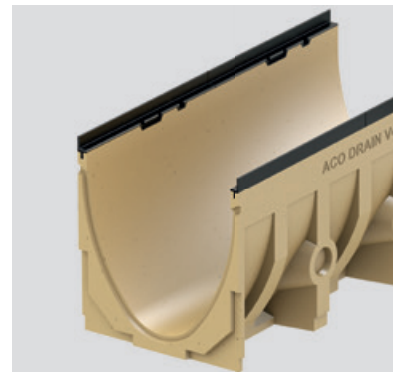

Multiline V 400



Multiline V 500

Safety lock Drainlock

A special feature of the Multiline concept is the Drainlock locking system. This locking system meets the demands on load, dynamics and protection of the environment, without making any compromises in terms of functionality. Through the use of state-of-the-art elastomers, it was possible to develop a unique, almost indestructible locking system. The geometry and material guarantee a reliable, screwless stop of the cover gratings, even under the highest dynamic traffic loads. Thanks to the horizontal anti-shifting device, the Drainlock system also allows the easy installation and removal of the cover gratings.



Screwless stop



Underground piping connection

Unlike conventional outlet shafts, any channel height can be connected to the ACO multi-function outlet shaft, whether with or without a gradient. This is made possible through the factory-made, integrated template end cap, which consists of an elastomeric plastic.

In addition, corner, T and cross connections can be established by opening the preformed blanks on the side surfaces.

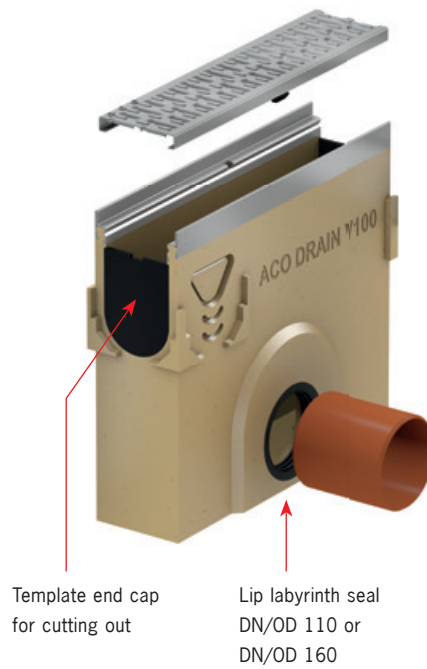

Template end cap for cutting out

Lip labyrinth seal DN/OD 110 or DN/OD 160

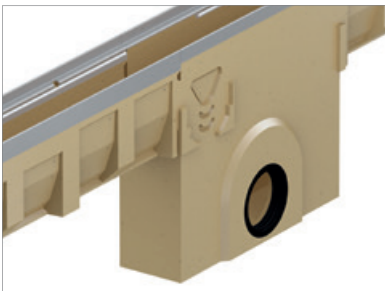

Multiline outlet shaft with lip labyrinth seal

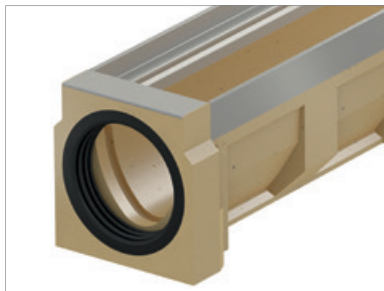

Multiline end cap with integral lip labyrinth seal

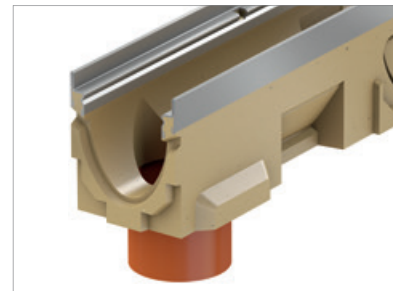

Multiline vertical gully with lip labyrinth seal

Ordering information about the new Drainlock gratings

	Material	Dimensions		Dimension of the inlet opening [mm]	Intake area [cm ² /m]	Weight [kg]	Article No.
		Length [mm]	Width [mm]				
Q+ mesh grating (load class B 125)							
	Stainless Steel	1000	123	30 x 10	845	3,2	132559
		500	123	30 x 10	845	1,6	132542
	Steel, galvanised	1000	123	30 x 10	845	3,2	132560
		500	123	30 x 10	845	1,6	132561
Longitudinal bar grating (load class B 125)							
	Stainless steel	1000	123	6	465	3,6	132557
		500	123	6	465	1,8	132552
Longitudinal profile grating (load class B 125)							
	Stainless steel	1000	123	8	430	3,9	132556
		500	123	8	430	1,9	132551
	Steel, galvanised	1000	123	8	430	3,9	132555
		500	123	8	430	1,9	132550
Ladder grating (load class D 400)							
	Cast iron EN-GJS	500	123	12	371	3,8	23408
		500	173	12	578	6,4	23164
		500	223	12	740	9,6	23224



T1
Line drainage
Point drainage
Sewer castings



T2
Separators
Backup solutions
Rainwater treatment
Pumping stations
Tree protection



P15
2015 Price List

The catalogue concept

ACO Civil Engineering can provide planners, builders and the trade with all product information from civil engineering and landscaping in one complete work. The technical manuals and the price list are included in a slipcase. The current documents are also available in digital form at:

www.aco-tiefbau.de/Service



draindesign.de – the Multiline grating configurator

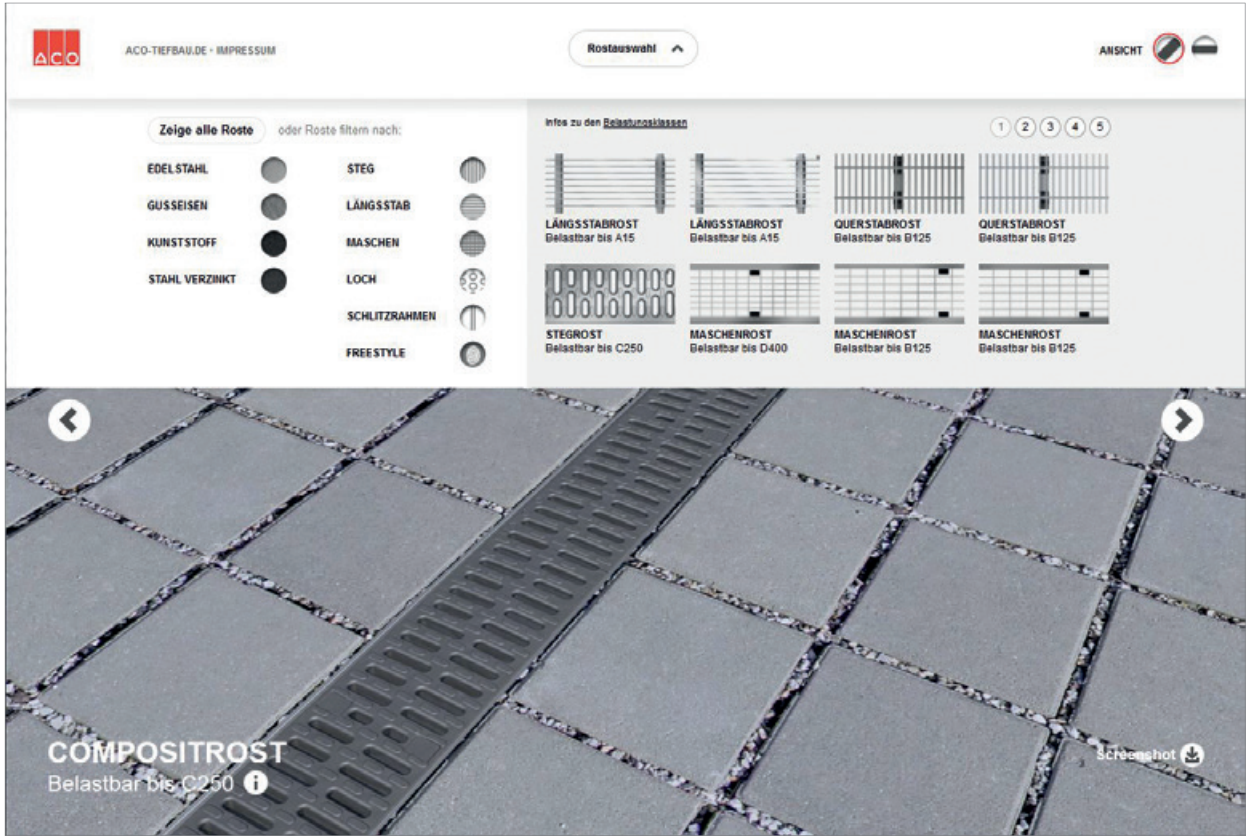

ACO Multiline grating configurator

The ACO Multiline grating configurator makes it possible for planners and architects to choose Multiline gratings according to visual criteria. The gratings are shown with different surfaces and in different scenarios. With these, planners and architects can look for inspiration in the design of their line drainage. All technical information regarding the selected Multiline Drainlock grating can be downloaded and saved in the object folder. The data sheet is generated at the click of a mouse, and also shows the selected combination of grating and surface coating.

www.draindesign.de

ACO Civil Engineering in the Internet

You can find our products with all of the information you need on the ACO Civil Engineering Internet site. You can thus access technical descriptions as well as the related pictorial information, brochures and article descriptions during the planning phase. Article master data can be downloaded directly from the ACO Civil Engineering homepage in the formats Pricat 1.2, Excel, Datnorm 4.0, TXT and PDF.

www.aco-tiefbau.de

The ACO Service Chain

The invitation to tender and the planning of drainage solutions allow many variants. But which concept will lead to the most cost-effective and the most reliable solution in technical terms?

Besides our products, we can offer you our know-how and our service in order to develop tailor-made solutions together with you – from planning to support after completion.

Your direct contact with ACO Civil Engineering:

www.aco-tiefbau.de/Kontakt



train: **Information and training**

In the ACO Academy, we share the know-how of the global ACO Group with architects, planners, processing agents and dealers, whose quality is important. We invite you to benefit from this.

design: **Planning and optimization**

The invitation to tender and the planning of drainage solutions allow many variants. But which concept will lead to the most cost-effective and the most reliable solution in technical terms? We will help you to find the right answer.

support: **Construction advice and support service**

To ensure that there are no unpleasant surprises between the planning and implementation of a drainage solution, we advise and support you in your project on your construction site.

care: **Inspection and maintenance**

ACO products are conceived and produced for a long life. With our after-sales service, we ensure that ACO still meets your high quality standards even after years.

**ACO. The future of
drainage.**

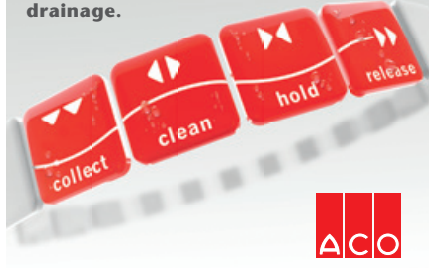

**The ACO system chain supports
every product by ACO Tiefbau**

- Drainage channels
- Street and yard drains
- Gully tops
- Manhole covers
- Separators
- Water pollution prevention
- Block storage and block infiltration
- Pumping stations
- Tree protection

ACO Severin Ahlmann GmbH & Co. KG

P.O. Box 320
24755 Rendsburg
Am Ahlmannkai
24782 Büdelsdorf
Germany
Phone + 49 (0)4331 354-0
Fax + 49 (0)4331 354-223

vertrieb-kg@aco.com
www.aco.com